

## Wood Shed Foundation Preparation

1. Verify the overall dimensions of your wood shed foundation. The excavation site should extend a minimum of 12 inches past the foundation in all directions.

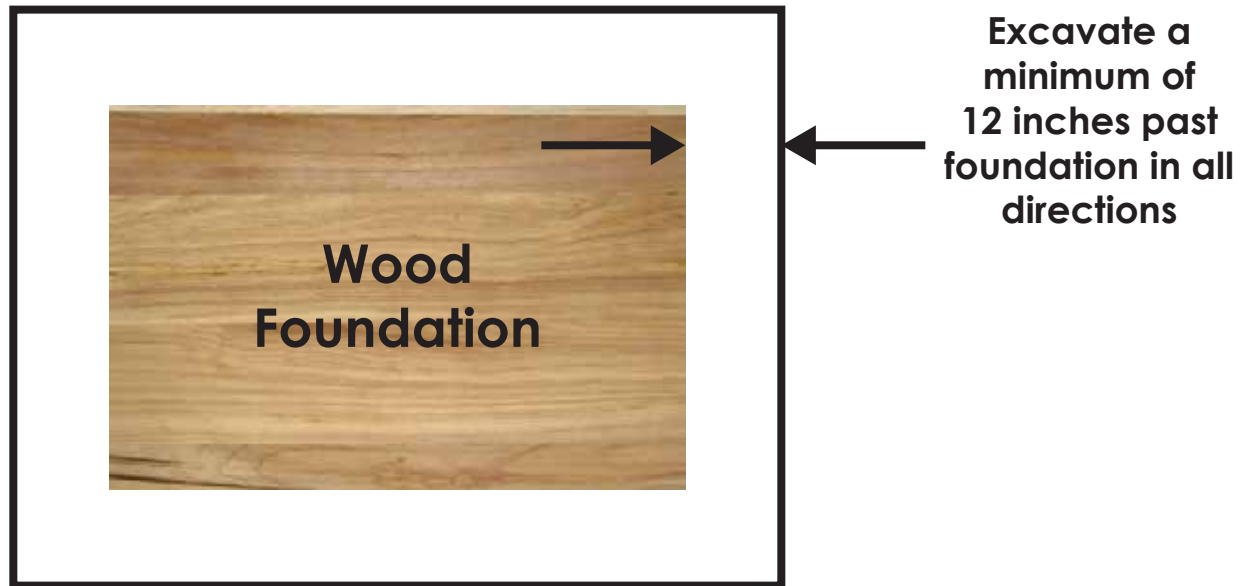

2. Consult local building codes for proper excavation depth (usually 4 - 6 inches). Be sure to level bottom of the site.
3. Fill excavation site with crushed gravel (road rock works best), and compact the entire site.
4. Level the top of the gravel base
5. Place wood shed foundation on gravel.



6. Consult local building codes for approved methods of anchoring wood foundation to ground (if desired).

BMS2500 WOOD PLATFORM DIMENSIONS

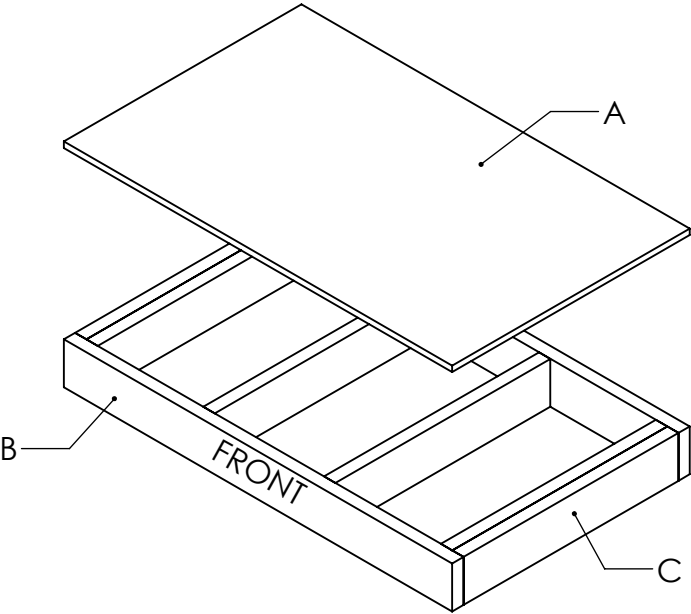
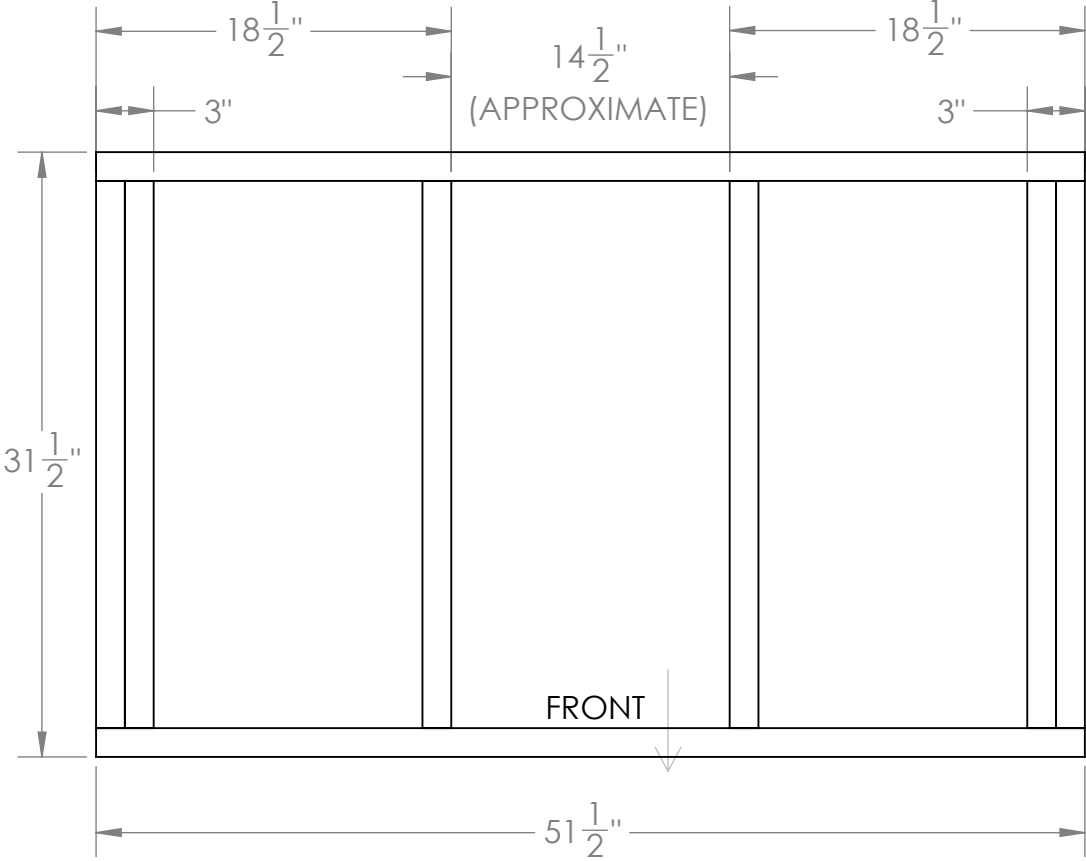

MATERIAL LIST:

ITEM	QTY	SIZE
A	1	31-1/2" x 51-1/2" x 3/4"
B	2	2" x 6" x 51-1/2"
C	6	2" x 6" x 28-1/2"

PLEASE NOTE-DIMENSIONAL LUMBER IS ACTUALLY 1/2" SMALLER THAN NOTED SIZES (A 2 X 6 BOARD ACTUALLY MEASURES 1-1/2" X 5-1/2")

# BMS2500 WOOD PLATFORM DIMENSIONS (METRIC)

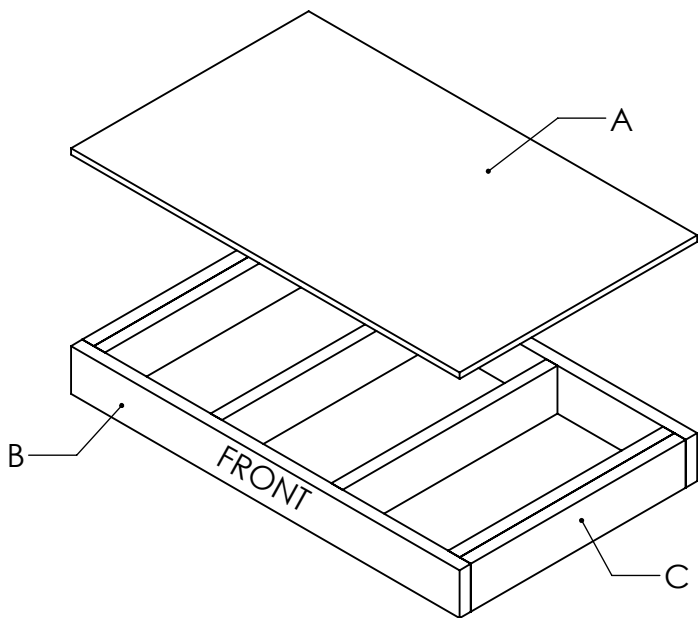
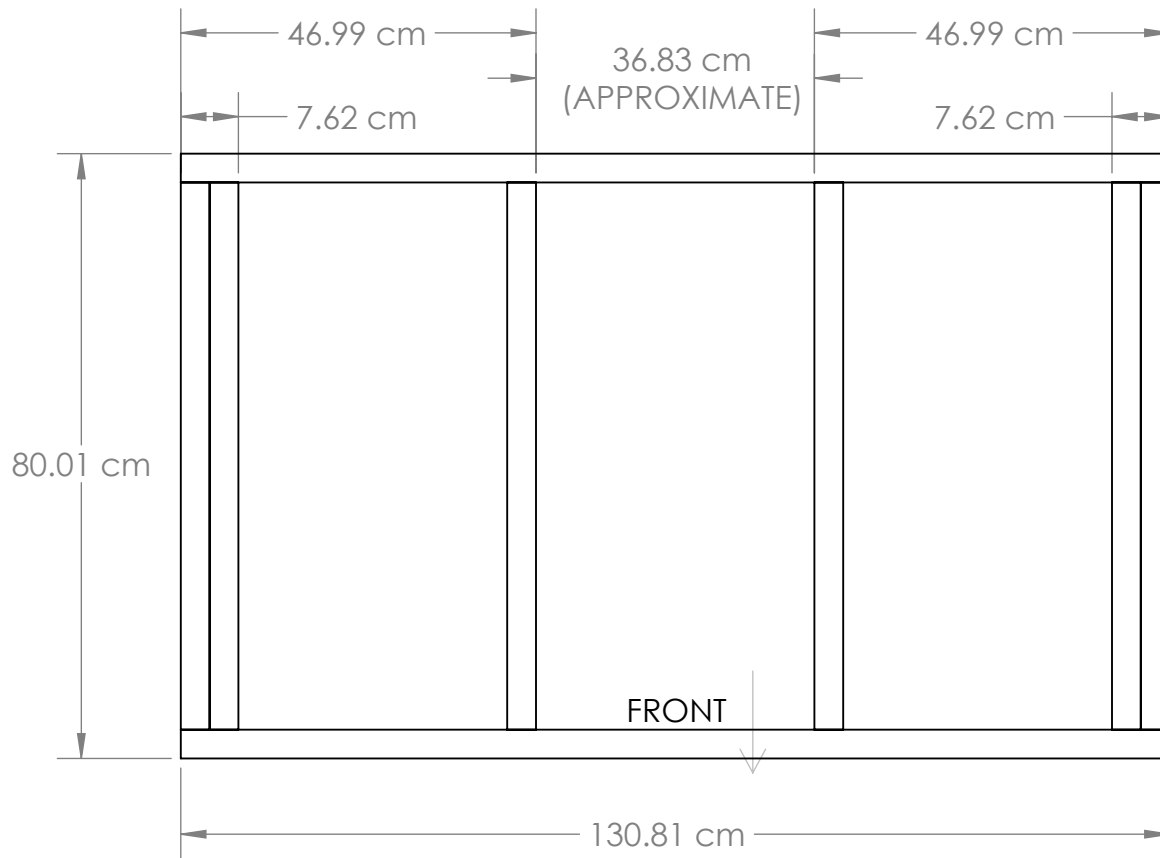

## MATERIAL LIST:

ITEM	QTY	SIZE (cm)
A	1	80.01 x 130.81 x 1.9
B	2	3.81 x 13.97 x 130.81
C	6	3.81 x 13.97 x 72.39

METRIC SIZING REFLECTS  
EXACT LUMBER DIMENSIONS